



by Schneider Electric

Smart-UPS™ VT™

10-40 kVA

380/400/415, 200/208/220 V

Operation



Table of Contents

About this Manual	1
How to find updates	1
Safety	2
Overview	3
User Interface	3
Display Interface	4
Menu Tree	5
Operation	7
Modes	7
Normal Operation	7
Battery Operation	7
Internal Bypass Operation	7
External Maintenance Bypass Operation	7
Optional Parallel Operation	7
Single System without External Bypass Panel	8
Turn into Internal Bypass	8
Turn into Normal Operation	9
Perform a Total Power Off	10
Perform a Restart	11
Single System with External Bypass Panel	12
Turn into External Maintenance Bypass	12
Turn into Normal Operation from External Maintenance Bypass	13
Perform a Total Power Off	14
Perform a Restart	14
Parallel System	15
Turn into External Maintenance Bypass	15
Turn into Normal Operation from External Maintenance Bypass	16
Perform a Total Power Off	17
Perform a Restart	17
Isolate one UPS in a Parallel System	18
Turn the Isolated UPS into Normal Operation	18
Single and Parallel Systems	19
Turn Load off/on via the Display Interface	19
Turn Load Off – Disconnect the UPS Output to the Load Equipment	19
Turn Load On – Connect the UPS Output to the Load Equipment	20
View the Status Screens	20
View Logging	22
View Statistics	23
Use the Diags Screen	24

Configuration	25
Settings	25
Change the Clock, the Alarm Thresholds, and the Dust Filter Status	25
Clock	26
Dust Filter	27
Alarm Thresholds	28
Change the Beeper Setup, the Contrast, and the Language	29
Maintenance	30
Parts Replacement	30
Determine if you Need a Replacement Part	30
Return Parts to APC	30
Remove the Front Panel	31
Install the Front Panel	32
Store the Batteries and the UPS System	32
Replace a Network Management Card	34
Install/ replace a Dust Filter	35
Replace a Battery Module	37
Troubleshooting	42
Status and Alarm Messages	42
Display Messages	42

About this Manual

This manual is intended for the user of the Smart-UPS® VT series. It refers to important safety warnings and instructions, gives an introduction to the display interface, and provides information on operation, load connection, parts replacement, troubleshooting, total power off and restart.



Note: Mainly graphics of Smart-UPS VT products with built-in batteries are shown in this manual, but the manual is intended for users of one or more units within the Smart-UPS VT series. Most illustrations show 523 mm enclosures but apply to both enclosure sizes. Any differences between the enclosure sizes will be addressed in the manual.

How to find updates

You can check for updates to this manual on www.apc.com. Look for the latest letter revision (A, B etc.) of the manual.

Safety



WARNING: All safety instructions in the Safety Sheet (990-2822) must be read, understood and followed prior to handling/using the system. Failure to do so could result in equipment damage, serious injury, or death.



WARNING: For safety reasons, only qualified personnel is allowed to perform the procedures described under “*Operation*” and “*Maintenance*”.

Overview

User Interface

The four LEDs to the left of the display indicate the operational status of the UPS. The five navigation keys to the right are used to select and open menu items, to access information, change system parameters, and to get context-sensitive help.

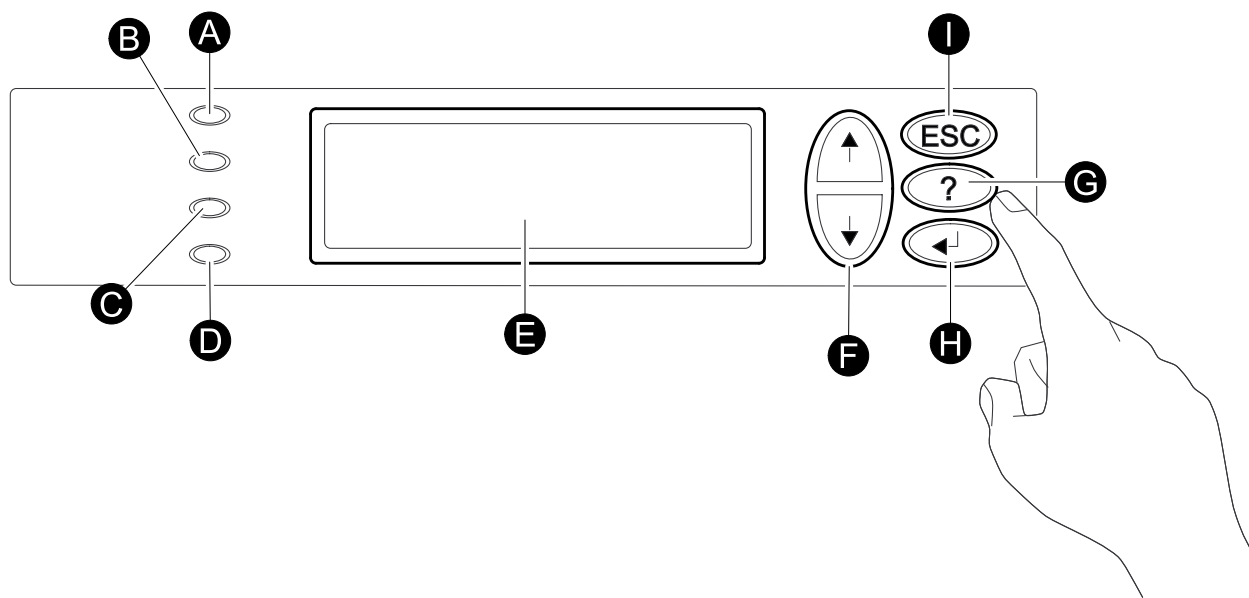

A	LOAD ON	When the green LED is lit, the UPS provides power to the load equipment.
B	ON BATT	When the yellow LED is lit, power flows from the batteries to the load.
C	BYPASS	When the yellow LED is lit, power to the load is supplied through bypass.
D	FAULT	When the red LED is lit, a fault condition exists.
E	LCD SCREEN	Displays alarms, status data, instructional help, and configuration items.
F	UP AND DOWN NAVIGATION KEYS	Used to scroll through and select menu items.
G	HELP KEY	Opens context-sensitive help.
H	ENTER KEY	Opens menu items and confirms changes to the system parameters.
I	ESC KEY	Returns to the previous screen displayed.

Display Interface

The Overview Screen is the main entrances to the user functions of the display interface. The **UP/DOWN** navigation keys take you from one screen to another.

The **ENTER** key takes you from the Overview Screen to the Main Screen.

From the Main Screen it is possible to command, configure, and monitor the system through the sub menu screens: **Control**, **Status**, **Setup**, **LCM**, **Logging**, **Display**, **Diags**, and **Help** (see “*Menu Tree*”). The selector arrow (→) is controlled by the **UP/DOWN** navigation keys. The arrow marks the item you may open by pressing **ENTER**.

Overview Screen

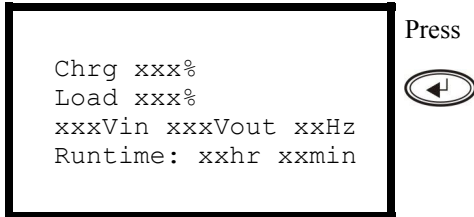

Main Screen

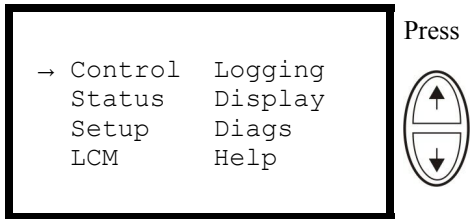

Menu Tree



Caution: The display provides access to more functions than described in this manual. Those functions should not be accessed without the assistance of APC Customer Support in order to avoid unwanted load impacts. For APC World-Wide Customer Support, refer to the back cover of this manual. If you by accident go beyond the functions described, press **ESC** to return to previous screens.

The menu tree provides a quick overview of the functions and views you may access.

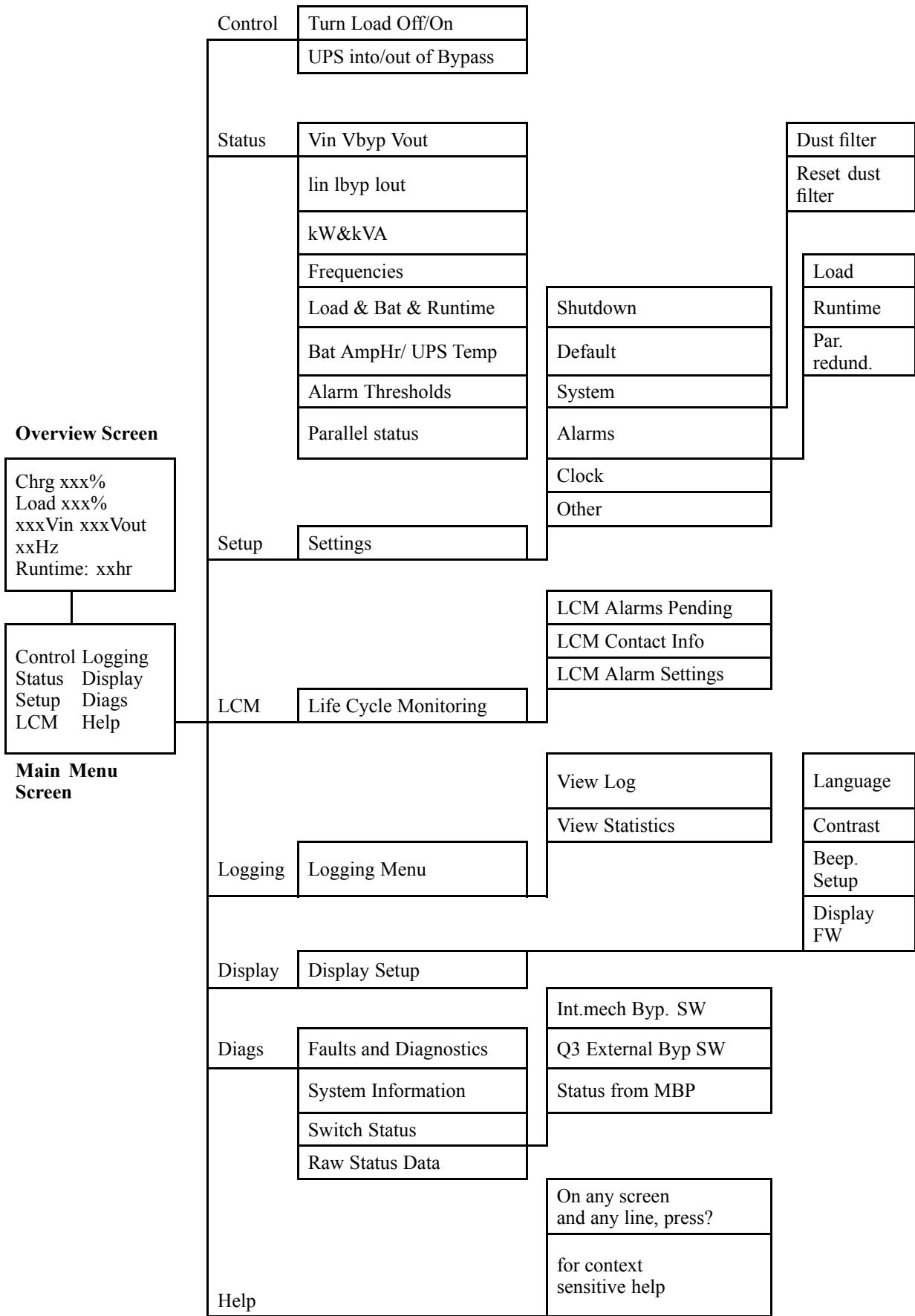

Operation



WARNING: For safety reasons, only qualified personnel is allowed to perform the operation procedures described in this chapter.

Modes

The UPS has different operation modes. If the installation includes a Maintenance Bypass Panel (MBP), an external maintenance bypass operation mode will also be available.

Normal Operation

The UPS converts utility/mains power to conditioned power for the connected load.

Battery Operation

The UPS provides power to the connected load from its internal and (if available) external batteries for a finite period. The UPS transfers to battery operation if the supply of utility/mains power fails, or is outside the pre-defined limits.

Internal Bypass Operation

Internal bypass keeps the load supplied with utility/mains power during maintenance of the UPS power sections. In internal bypass operation, utility/mains power is sent directly to the connected load bypassing all internal UPS functions and filters. Battery back-up is not available in internal bypass operation even though the batteries are in place.

External Maintenance Bypass Operation

The UPS can be connected to an optional external MBP. When activated, this panel bypasses the entire UPS enclosure, feeding utility/mains power directly to the load. An activated external MBP **completely** isolates the UPS and allows maintenance to be performed. An external MBP is mandatory if the UPS is running in parallel.

Optional Parallel Operation

The connected load is powered by multiple UPS units to increase system redundancy or to increase power. The internal mechanical bypass lever is not available.

Single System without External Bypass Panel



WARNING: For safety reasons, only qualified personnel is allowed to perform the operation procedures described in this chapter.

Turn into Internal Bypass



WARNING: In bypass operation the batteries are still powered. If a total power off is required, the load must be off, and the batteries must be pulled out to the red disconnect line, see the section “*Perform a Total Power Off*”.



Caution: The load is not protected by the UPS and the power is not conditioned when the internal mechanical bypass lever is activated



Note: This procedure is not applicable to parallel systems as the internal mechanical bypass lever is unavailable.

1. If the UPS is running and controllable through the display, carry out steps 2-5. If not, go directly to step 6.
2. From the Overview Screen, press **ENTER**.

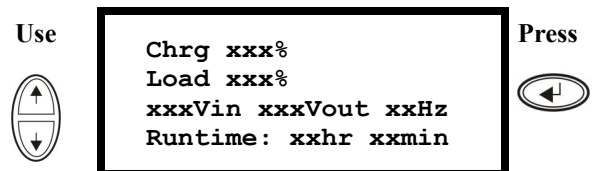

3. Go to **Control** by using the **UP/DOWN** navigation keys and press **ENTER**.

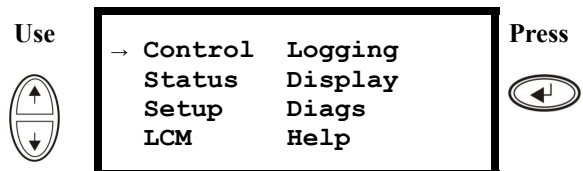

4. Go to **UPS into Bypass** by using the **UP/DOWN** navigation keys and press **ENTER**.

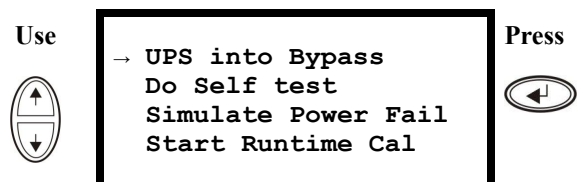

5. Go to **YES, UPS into Bypass** by using the **UP/DOWN** navigation keys and press **ENTER**.

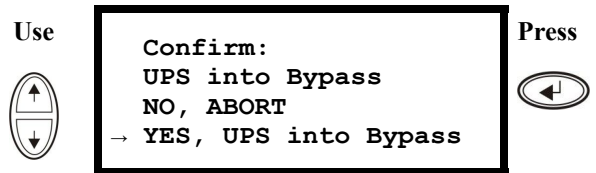

6. Check that the UPS is in bypass. The green (LOAD ON) and the yellow (BYPASS) LEDs are illuminated.



WARNING: For safety reasons, only qualified personnel is allowed to perform the following steps.

7. Remove the front panel from the UPS (see *“Remove the Front Panel”*).
8. Turn the internal mechanical bypass lever upwards to activate it. The load will now be supported directly by utility/mains power.
9. Reinstall the front panel.

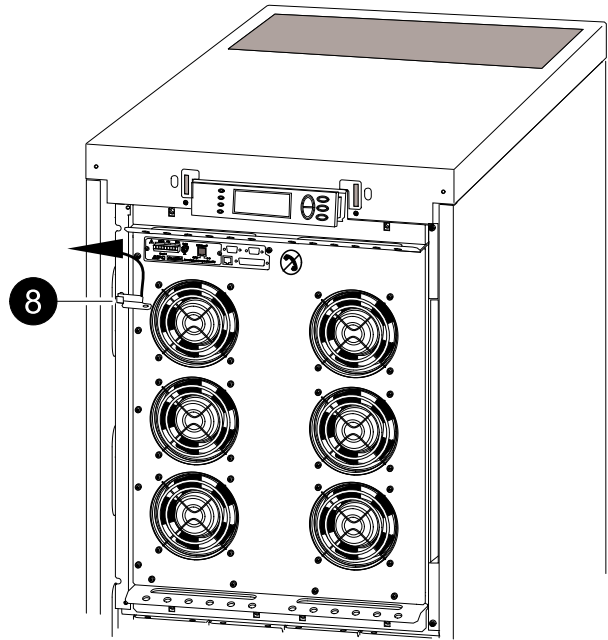

Turn into Normal Operation



Caution: Never attempt to switch back the UPS into normal operation till you have verified that there are no internal UPS faults.

1. Check that the UPS is in bypass. The green (LOAD ON) and the yellow (BYPASS) LEDs are illuminated.
2. Turn the mechanical bypass lever downwards into a horizontal position to deactivate the internal bypass operation.
3. If the UPS has not returned to normal operation: Press ESC to return to the previous menus and turn out of bypass from the display via **Control > UPS out of bypass > Yes, UPS out of bypass**.

4. Check that the UPS is in normal operation. The yellow (BYPASS) LED turns off and the green (LOAD ON) LED remains illuminated.

Perform a Total Power Off



Note: In order to carry out this procedure the load supported by the UPS must be turned off.

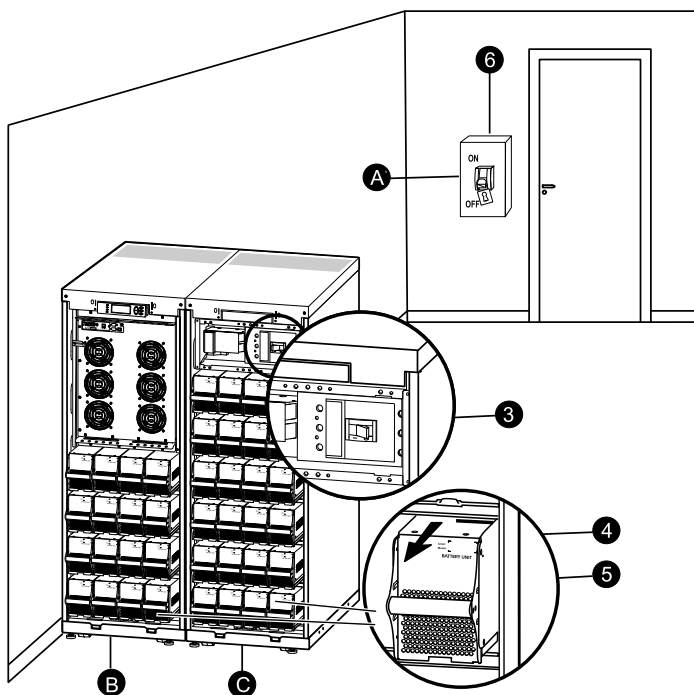

A	Mains breaker
B	UPS
C	XR Enclosure

1. Check that the load which is supported by the UPS is turned OFF.
2. From the UPS: Turn load OFF from the display via **Control > Turn Load Off > Yes, Turn Load Off**.
3. From the XR Enclosure(s) (if available): Set the DC disconnect switch(es) to position OFF.
4. From the UPS: Disconnect the batteries (if available) by pulling them out to the red disconnect line shown on each battery unit.
5. From the XR Enclosure(s) (if available): Disconnect the batteries by pulling them out to the red disconnect line shown on each battery unit.
6. Set the utility/mains breaker to position OFF or LOCKED-OUT. If the UPS has dual utility/mains supply, set both supplies to position OFF or LOCKED-OUT.



WARNING: The lockout procedures at the utility/mains breaker must be followed. If necessary, install a padlock.



Note: For details on how to remove Battery Locks (if available) (see the section “*Replace a Battery Module*” and hereunder “*Remove and Install Battery Locks*”).

Perform a Restart



WARNING: Only qualified personnel familiar with the construction and the equipment may restart the UPS.

1. Set the utility/mains breaker to position ON.

2. If your installation includes an XR Battery Enclosure with a DC disconnect switch, set the DC disconnect switch to position ON.



Note: Wait approximately 30 seconds for the system to boot up and carry out a self test.

After system boot-up, the display will automatically ask you to confirm/select voltage and frequency as shown in the following.

Voltage confirmation. At restart, the display will prompt you through the following screens:

3. When the **Confirm Voltage** prompt appears on the screen, go to the desired voltage using the **UP/DOWN** navigation keys and press **ENTER**.

Use



```
Confirm Voltage
Use 400V
→ Yes, use 400V
No, select another
```

Press



4. When the prompt **Apply load** appears, go to **Yes** using the UP/DOWN navigation keys and press **ENTER** if you want the UPS to provide a load output now. (If you do not want a UPS load output at this point, go to **No**).

Use



```
Apply load
→ Yes
No
```

Press



5. The green (LOAD ON) LED is now lit. Press **ESC** two times and the display will return to the Overview Screen.

Use



```
Chrg xxx%
Load xxx%
xxxVin xxxVout xxHz
Runtime: xxhr xxmin
```

Press



Note: The UPS is now ready to support the load.



Note:

The auto-detection on frequency has been improved in firmware version 5.1 and higher for the Smart-UPS VT single units (with parallel capability). Auto-detection on frequency is an option in the Setup menu (in alignment with the values 50Hz and 60Hz) but also a feature whereby a single UPS system detects the input frequency in a system start-up.

If the UPS system during a start-up detects an input frequency different from what is already set, then the user will be asked to choose the detected frequency. The system will not change frequency by itself. For safety reasons, the input frequency can only be changed by the user. The auto-detection on frequency-feature is only applicable in a single system start-up. If a problem occurs call APC Customer Support (see the back cover of this manual).

Single System with External Bypass Panel



WARNING: For safety reasons, only qualified personnel is allowed to perform the operation procedures described in this chapter.

Turn into External Maintenance Bypass



WARNING: In bypass operation the batteries are still powered. If a total power off is required, the load must be off, and the batteries must be pulled out to the red disconnect line (see “Perform a Total Power Off” in this chapter).

1. From the Overview Screen, press **ENTER**.

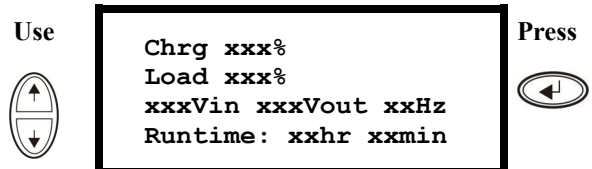

2. Go to **Control** by using the **UP/DOWN** navigation keys and press **ENTER**.

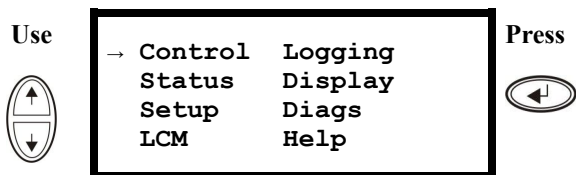

3. Go to **UPS into Bypass** by using the **UP/DOWN** navigation keys and press **ENTER**.

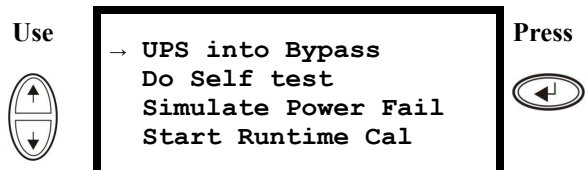

- Go to **Yes, UPS into Bypass** by using the **UP/DOWN** navigation keys and press **ENTER**.

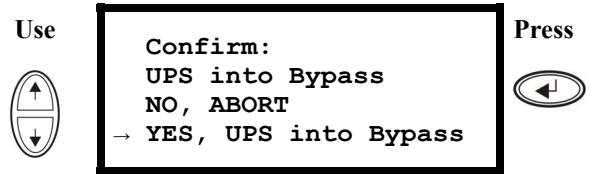

- From the external Maintenance Bypass Panel (MBP): Turn the bypass switch (Q3) to position “|” (ON).

- From the external MBP: Turn the output switch (Q2) to position “O” (OFF). Now the load is not supported by the UPS.



Note: Note! If you need to turn the UPS completely OFF, proceed with steps 7–11.

- If you need to turn the UPS completely OFF: From the external MBP: Turn the input switch (Q1) to position “O” (OFF).

- From the XR Enclosure(s) (if available): Set the DC disconnect switch(es) to position OFF.

- From the UPS: Disconnect the batteries (if available) by pulling them out to the red disconnect line shown on each battery unit.

- From the XR Enclosure(s) (if available): Disconnect the batteries by pulling them out to the red disconnect line shown on each battery unit.

Turn into Normal Operation from External Maintenance Bypass



Caution: Never attempt to switch back the UPS into normal operation till you have verified that there are no internal UPS faults.

- If the UPS has been completely turned OFF, proceed with steps 2–10. If the UPS has not been completely turned OFF, proceed with steps 6–10.
- From the XR Enclosure(s) (if available): Connect the batteries by pushing them in.
- From the UPS: Connect the batteries (if available) by pushing them in.
- From the XR Enclosure(s) (if available): Set the DC disconnect switch(es) to position ON.
- From the XR Enclosure(s) (if available): Set the DC disconnect switch(es) to position ON.
- From the external MBP: Turn the output switch (Q2) to position “|” (ON). Now the load is supported by the UPS.
- From the UPS: Check that the yellow (BYPASS) LED is illuminated and the green (LOAD ON) LED is illuminated.
- From the external MBP: Turn the bypass switch (Q3) to position “O” (OFF).
- If the UPS has not returned to normal: From the UPS: Turn out of bypass from the display via **Control > UPS out of bypass > Yes, UPS out of bypass**.
- From the UPS: Check that the UPS is in normal operation. The yellow (BYPASS) LED turns off and the green (LOAD ON) LED remains illuminated.

Perform a Total Power Off



Note: In order to carry out this procedure the load supported by the UPS must be turned off.

1. Check that the load which is supported by the UPS is turned OFF.
2. From the UPS: Turn load OFF from the display via **Control > Turn Load Off > Yes, Turn Load Off**.
3. From the external MBP: Turn the output switch (Q2) to position “O” (OFF).
4. From the external MBP: Turn the input switch (Q1) to position “O” (OFF).
5. From the XR Enclosure(s) (if available): Set the DC disconnect switch to position OFF.
6. From the UPS: Disconnect the batteries (if available) by pulling them out to the red disconnect line shown on each battery unit.
7. From the XR Enclosure(s) (if available): Disconnect the batteries by pulling them out to the red disconnect line shown on each battery unit.

Perform a Restart



Note: Only qualified personnel familiar with the construction and the equipment may restart the UPS.

1. From the XR Enclosure(s) (if available): Connect the batteries by pushing them in.
2. From the UPS: Connect the batteries (if available) by pushing them in.
3. From the XR Enclosure(s) (if available): Set the DC disconnect switch(es) to position ON.
4. From the external MBP: Turn the input switch (Q1) to position “I” (ON).
5. From the external MBP: Turn the output switch (Q2) to position “I” (ON).
6. From the UPS: Turn load ON from the display via **Control > Turn Load On > Yes, Turn Load On**.
7. Check that the load is ON.



Note: The UPS is now ready to support the load.



Note: The auto-detection on frequency has been improved in firmware version 5.1 and higher for the Smart-UPS VT single units (with parallel capability). Auto-detection on frequency is an option in the Setup menu (in alignment with the values 50Hz and 60Hz) but also a feature whereby a single UPS system detects the input frequency in a system start-up.

If the UPS system during a start-up detects an input frequency different from what is already set, then the user will be asked to choose the detected frequency. The system will not change frequency by itself. For safety reasons, the input frequency can only be changed by the user. The auto-detection on frequency-feature is only applicable in a single system start-up. If a problem occurs call APC Customer Support (see the back cover of this manual).

Parallel System



WARNING: For safety reasons, only qualified personnel is allowed to perform the operation procedures described in this chapter.





WARNING: Parallel Operation is not available when the system is set up for 3-wire operation, which only applies to Japanese systems.

Turn into External Maintenance Bypass



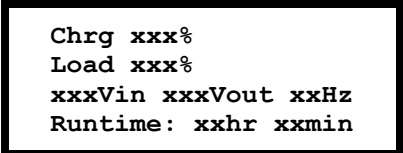

WARNING: In bypass operation the batteries are still charged. If a total power off is required, the load must be off and the batteries must be pulled out to the red disconnect line (see “Perform a Total Power Off” in this chapter).

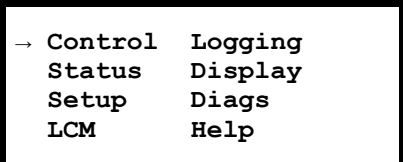

1. From the Overview Screen, press **ENTER**.

Use   Press 

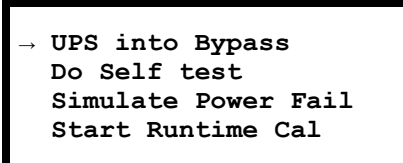

2. Go to **Control** by using the **UP/DOWN** navigation keys and press **ENTER**.

Use   Press 

3. Go to **UPS into Bypass** by using the **UP/DOWN** navigation keys and press **ENTER**.

Use   Press 

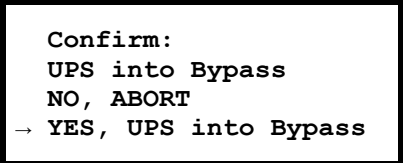
4. Go to **YES, UPS into Bypass** by using the **UP/DOWN** navigation keys and press **ENTER**.

Use   Press 

5. From the UPS: Check that all UPS units are in bypass on each of the displays. The yellow bypass LED is illuminated on each UPS unit.

6. From the external Maintenance Bypass Panel (MBP): Check that the bypass lamp indicator (H3) is illuminated at Q3.

7. From the external MBP: Turn the bypass switch (Q3) to position “I” (ON).
8. From the external MBP: Check that the lamp indicator of the output isolation breaker (H4) at Q4 is illuminated.
9. From the external MBP: Turn the output isolation breaker (Q4) to position “O” (OFF). The UPS is now in external maintenance bypass with the batteries still powered. Note! If you need to turn the UPS units completely OFF, proceed with steps 11–18.
10. From the UPS: Turn OFF each UPS unit from the display via **Control > Turn Load Off > Yes, Turn Load Off**.



Note: Note! If you need to turn the UPS units completely OFF, proceed with steps 11–18.

11. From the external MBP: Check that all the output lamps (H2a, H2b, H2c) for Q2 are illuminated.
12. From the external MBP: Turn all output switches (Q2) to position “O” (OFF).
13. From the external MBP: turn all input switches (Q5) (if available) to position “O” (OFF).
14. From the external MBP: Turn all input switches (Q1) to position “O” (OFF).
15. From the XR Enclosure(s) (if available): Set the DC disconnect switch(es) to position OFF.
16. From the UPS: Disconnect the batteries (if available) by pulling them out to the red disconnect line shown on each battery unit.
17. From the XR Enclosure(s) (if available): Disconnect the batteries by pulling them out to the red disconnect line shown on each battery unit.
18. De-energize all UPS inputs.

Turn into Normal Operation from External Maintenance Bypass



Caution: Never attempt to turn the UPS into normal operation till you have verified that there are no internal UPS faults.

1. If the UPS units have been completely turned OFF, proceed with steps 2–16. If the UPS units have not been completely turned OFF, proceed with step 13–16.
2. From the UPS: Connect the batteries (if available) in each UPS by pushing them in.
3. From the XR Enclosure(s) (if available): Connect the batteries in each UPS by pushing them in.
4. From the XR Enclosure(s) (if available): Set the DC disconnect switch(es) to position ON.
5. From the external MBP: Turn all input switches (Q1) to position “I” (ON).
6. From the external MBP: Check that all the bypass input lamps (H5) at Q5 (if available) are illuminated.
7. From the external MBP: Turn all bypass input switches (Q5) (if available) to position “I” (ON).
8. From the external MBP: Check that all the output lamps (H2) for Q2 are illuminated.
9. From the external MBP: Turn all output switches (Q2) to position “I” (ON). The lamp indicator of the output isolation breaker (Q4) is still illuminated.
10. From the UPS: Turn ON all UPS units from each display via **Control > Turn Load ON > Yes, Turn Load ON**. The green online LEDs are illuminated on each UPS unit.

11. From the external MBP: Check that all the output lamps (H2) for Q2 are not illuminated and that all the bypass input lamps (H5) at Q5 (if available) are not illuminated.
12. From the UPS: Turn the UPS units into bypass from one UPS display via **Control > UPS into bypass > Yes, UPS into bypass**. Check that the UPS units are in bypass. The green (LOAD ON) and the yellow (BYPASS) LEDs are illuminated.
13. From the external MBP: Check that the lamp indicator of the output isolation breaker (Q4) is illuminated.
14. From the external MBP: Turn the output isolation breaker (Q4) to position “|” (ON). Now the lamps H3 + H4 are illuminated.
15. From the external MBP: Turn the bypass switch (Q3) to position “O” (OFF). The lamp indicator of the output isolation breaker (H4) for Q4 is not illuminated, but the bypass lamp (H3) for Q3 is illuminated, until the UPS is running in normal operation.
16. From the UPS: Turn the UPS units out of bypass from the display via **Control > UPS out of bypass > Yes, UPS out of bypass**.

Perform a Total Power Off



Note: In order to carry out this procedure the load supported by the UPS must be turned off.

1. Check that the load which is supported by the UPS is turned OFF.
2. From the UPS: Turn load OFF from each of the UPS displays via **Control > Turn Load Off > Yes, Turn Load Off**.
3. From the external MBP: Turn the output isolation breaker (Q4) to position “O” (OFF).
4. From the external MBP: Turn all output switches (Q2) to position “O” (OFF).
5. From the external MBP: Turn all input switches (Q1) to position “O” (OFF).
6. From the XR Enclosure(s) (if available): Set the DC disconnect switch(es) to position OFF.
7. From the external MBP: Turn all bypass input switches (Q5) (if available) to position “O” (OFF).
8. From the UPS: Disconnect the batteries in the UPS units by pulling them out to the red disconnect line shown on beach battery unit.
9. From the XR Enclosure(s) (if available): Disconnect the batteries on the UPS units by pulling them out to the red disconnect line shown on each battery unit.
10. De-energize all UPS inputs.

Perform a Restart



WARNING: Only qualified personnel familiar with the construction and the equipment may restart the UPS system.

1. From the XR Enclosure(s) (if available): Connect the batteries by pushing them in.
2. From the UPS: Connect the batteries (if available) by pushing them in.
3. From the XR Enclosure(s) (if available): Set the DC disconnect switch(es) to position ON.
4. From the external MBP: Turn all input switches (Q1) to position “|” (ON).
5. From the external MBP: Turn all bypass input switches (Q5) (if available) to position “|” (ON).
6. From the external MBP: Turn all output switches (Q2) to position “|” (ON).
7. From the external MBP: Turn the output isolation breaker (Q4) to position “|” (ON).

8. From the UPS: Turn load ON from the display of each UPS via **Control > Turn Load On > Yes, Turn Load On**.
9. Check that the load is ON.



Note: The UPS system is now ready to support the load.

Isolate one UPS in a Parallel System

1. From the UPS: From the Main screen select **Status** and scroll down to **Status of actual redundancy: n+** in order to check that the remaining UPS(s) will be able to support the load when one UPS is isolated.
2. From the UPS: Turn load OFF (from the display on the UPS to be isolated) via **Control > Turn Load Off > Yes, Turn Load Off**.
3. From the external MBP: Check that the output lamp (H2) for Q2 (of the UPS to be isolated) is illuminated.
4. From the external MBP: Turn the output switch (Q2) (of the UPS to be isolated) to position “O” (OFF).
5. From the external MBP: Check that the bypass input lamp (H5) at Q5 (if available) is illuminated.
6. From the external MBP: Turn the bypass input switch (Q5) (if available) to position “O” (OFF).
7. From the external MBP: Turn the input switch (Q1) (of the UPS to be isolated) to position “O” (OFF).
8. From the XR Enclosure(s) (if available): Set the DC disconnect switch(es) to position OFF.
9. From the UPS: Disconnect the batteries (if available) in the UPS to be isolated by pulling them out to the red disconnect line shown on each battery unit.
10. From the XR Enclosure(s) (if available): Disconnect the batteries by pulling them out to the red disconnect line shown on each battery unit.

Turn the Isolated UPS into Normal Operation

1. From the XR Enclosure(s) (if available): Connect the batteries by pushing them in.
2. From the UPS: Connect the batteries (if available) by pushing them in.
3. From the XR Enclosure(s) (if available): Set the DC disconnect switch(es) to position ON.
4. From the external MBP: Turn the input switch (Q1) (of the UPS to be turned into normal operation) to position “I” (ON).
5. From the external MBP: Check that the bypass input lamp (H5) at Q5 (if available) is illuminated.
6. From the external MBP: Turn the bypass input switch (Q5) (if available) to position “I” (ON).
7. From the external MBP: Check that the output lamp (H2) for Q2 (of the UPS to be turned into normal operation) is illuminated.
8. From the external MBP: Turn the output switch (Q2) (of the UPS to be turned into normal operation) to position “I” (ON) .
9. From the UPS: Turn load ON (from the display on the UPS to be turned into normal operation) via **Control > Turn Load on > Yes, turn Load on**.
10. From the UPS: Press ESC two times to get back to the Overview Screen.
11. From the UPS: On each Overview Screen, check that the load percentage of the UPS units is approximately the same.

Single and Parallel Systems

Turn Load off/on via the Display Interface



WARNING: Warning: Disconnecting the UPS output to the load does NOT de-energize the UPS! Always follow the total power off procedure in the respective chapters if you need to de-energize the UPS in emergency situations.

Turn Load Off – Disconnect the UPS Output to the Load Equipment

1. From the Overview Screen, press **ENTER**.

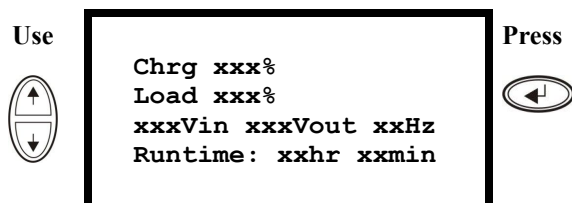

2. Go to **Control** by using the **UP/DOWN** navigation keys and press **ENTER**.

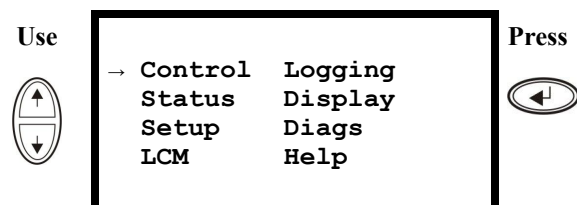

3. Go to **Turn Load OFF** by using the **UP/DOWN** navigation keys and press **ENTER**.

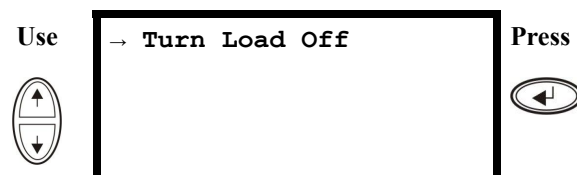

4. Go to **YES, Turn Load OFF** by using the **UP/DOWN** navigation keys and press **ENTER**.

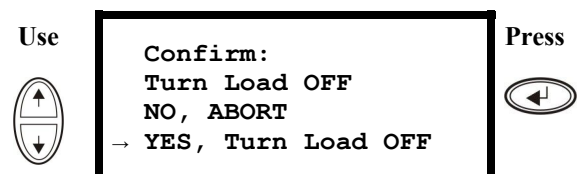

5. If the UPS is running in parallel operation this procedure must be carried out on each UPS.

Turn Load On – Connect the UPS Output to the Load Equipment



1. From the Overview Screen, press **ENTER**.

Press 

```

Chrg xxx%
Load xxx%
xxxVin xxxVout xxHz
Runtime: xxhr xxmin
    
```



2. Go to **Control** by using the **UP/DOWN** navigation keys and press **ENTER**.

Use  Press 

```

→ Control  Logging
   Status  Display
   Setup   Diags
   LCM     Help
    
```



3. Go to **Yes, Turn Load ON** by using the **UP/DOWN** navigation keys and press **ENTER**.

Use  Press 

```

→ Turn Load On
    
```

4. Go to **Turn Load ON** by using the **UP/DOWN** navigation keys and press **ENTER**.

Use  Press 



```

Confirm:
Turn Load OFF
NO, ABORT
→ YES, Turn Load ON
    
```

5. If the UPS is running in parallel operation this procedure must be carried out on each UPS.

View the Status Screens



1. From the Overview Screen, press **ENTER**.

Use  Press 

```

Chrg xxx%
Load xxx%
xxxVin xxxVout xxHz
Runtime: xxhr xxmin
    
```

2. Go to **Status** by using the **UP/DOWN** navigation keys and press **ENTER**.

Use  Press 

```

Control  Logging
→ Status  Display
   Setup   Diags
   LCM     Help
    
```



3. Use the **UP/DOWN** keys to go through the below parameters and press the **ESC** key to return to the previous menus.

View	Parameters
Voltage on all phases	Utility/mains voltage (V), bypass voltage (V), and output voltage (V) for each phase.
Current on all phases	Utility/mains current (A), bypass current (A), and output current (A) for each phase.
kVA and kW	Apparent power (kVA) and real power (kW) generated by the UPS and the connected load.
Frequencies	Utility/mains frequency, bypass frequency, and output frequency in Hertz (Hz).
Load and batteries	Load: Percentage of the load in relation to the total UPS capacity.
Bat Voltage	Shows either the positive or negative half of the battery voltage (the lower value of the two will appear).
Bat Cap	Percentage charge on the batteries in relation to the total battery capacity. Runtime: The predicted runtime at the present load.
Batteries	Bat AmpHr: Battery capacity, including both external and internal batteries. UPS Temp: The highest external battery temperature.
Alarm thresholds	Load: An alarm will be set when the load is above the threshold level. Runtime: An alarm will be set when the runtime is below the threshold level.
Parallel Status	Local UPS is slave/master: # of UPSs OK: Indicates the number of parallel UPS units that is OK # of UPSs fail: Indicates the number of parallel UPS that has failed.
Par load Status	KVA and KW: Total apparent power (kVA) and real power (kW) generated by the parallel UPS units and the connected load. Par redundancy: n+1, an alarm will be set if the redundancy level is below the threshold level.
Parallel Operation Mode	The parallel operation mode can be off, load on, requested bypass, in bypass due to fault or maintenance.

View Logging

View the 100 most recent UPS log events, and view the logged details of the events, such as date, time of occurrence, and event number.

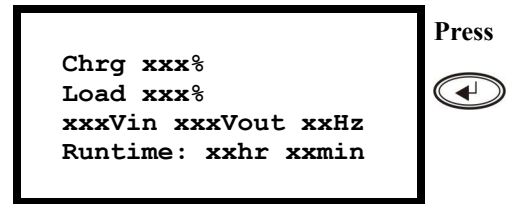
1. From the Overview Screen, press **ENTER**.



2. Go to **Logging** by using the **UP/DOWN** navigation keys and press **ENTER**.

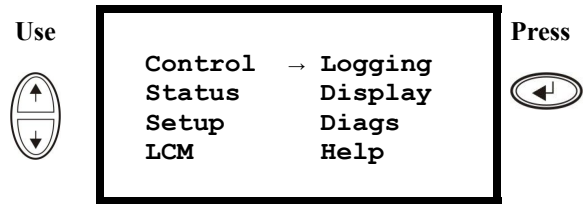

3. Go to **View Log** by using the **UP/DOWN** navigation keys and press **ENTER**.

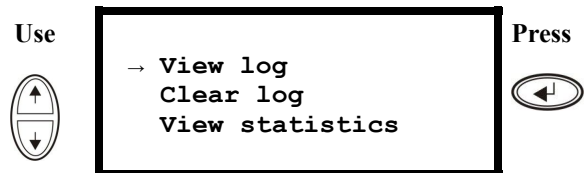

4. Go to **On Line** by using the **UP/DOWN** navigation keys and press **ENTER**.

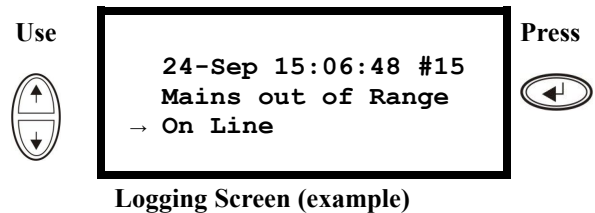

5. The top line states date, time, and event number. Lines 2, 3, and 4 are part of the event list. To view the entire list: Use the **UP/DOWN** keys to go through the log events and press **ENTER** to get a detailed description of a particular event.

View Statistics

View the statistics on the operation mode changes, the inverter time, and the duration of battery operation.

1. From the Overview Screen, press **ENTER**.

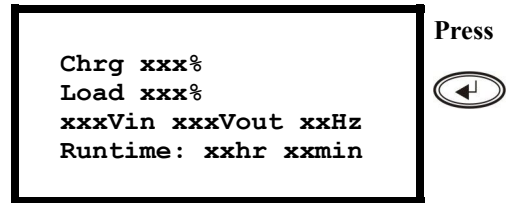

2. Go to **Logging** by using the **UP/DOWN** navigation keys and press **ENTER**.

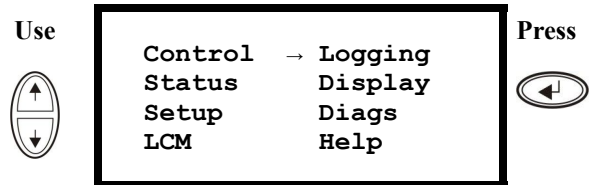

3. Go to **View Statistics** by using the **UP/DOWN** navigation keys and press **ENTER**.

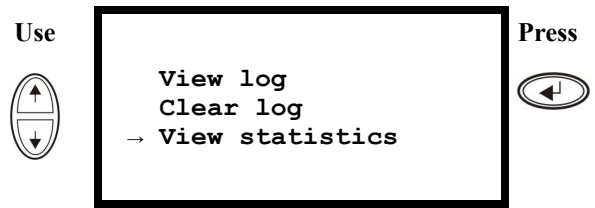

Use the Diags Screen

View troubleshooting information

1. From the Overview Screen, press **ENTER**.

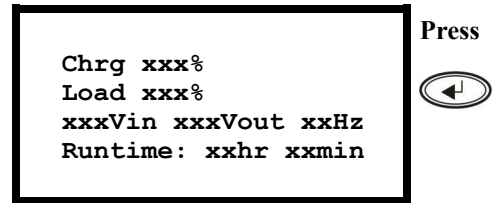

2. Go to **Diags** by using the **UP/DOWN** navigation keys and press **ENTER**.

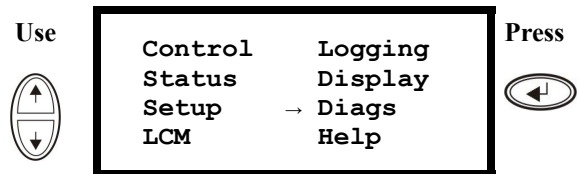

3. Go to **Fault & Diagnostics** by using the **UP/DOWN** navigation keys and press **ENTER**.

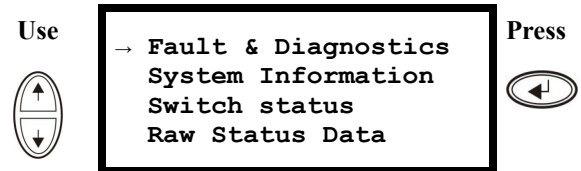

Note: For more details on the Fault and Diagnostics screens, see the section *“Troubleshooting”*.

Configuration

Settings

Change the Clock, the Alarm Thresholds, and the Dust Filter Status

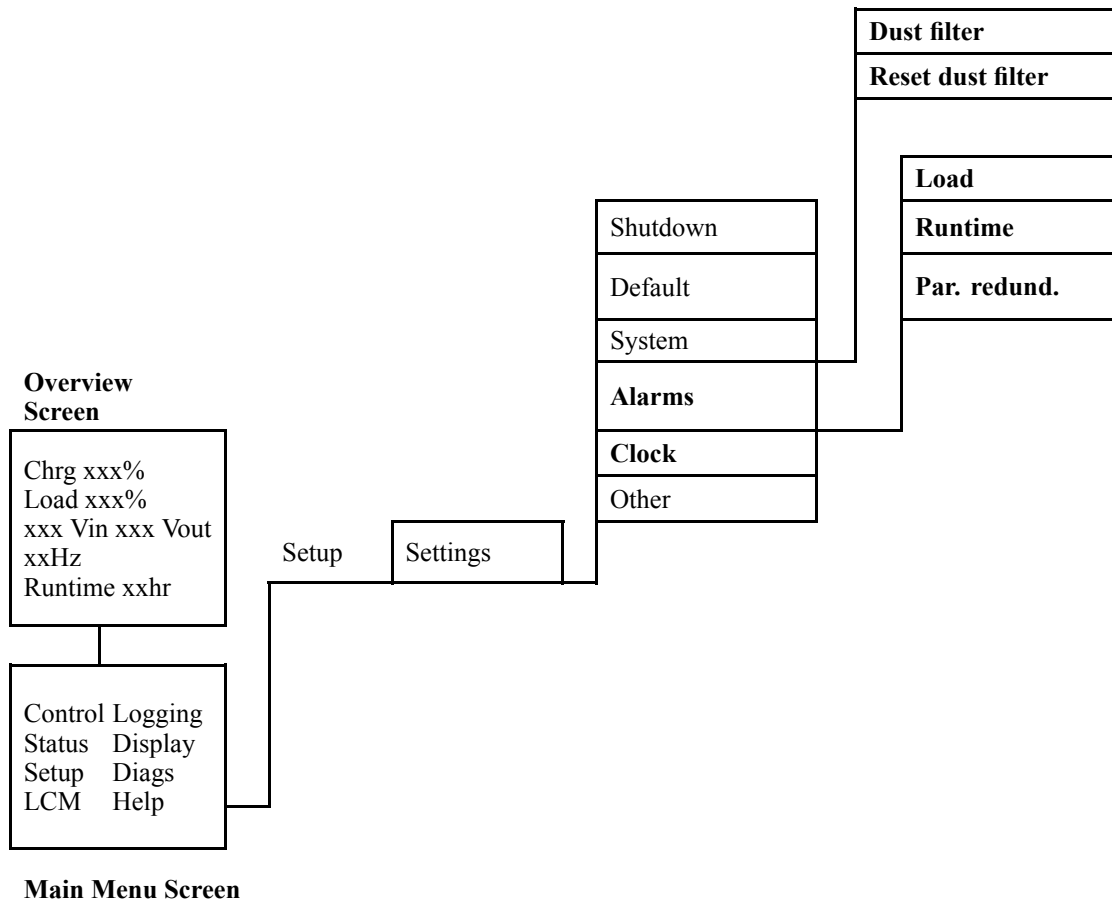

Clock

The **Clock** menu changes the date and the clock settings and it time-stamps events in the event log. To avoid inaccuracies, change the clock-setting at daylight-saving time.

1. From the Overview Screen, press **ENTER**.

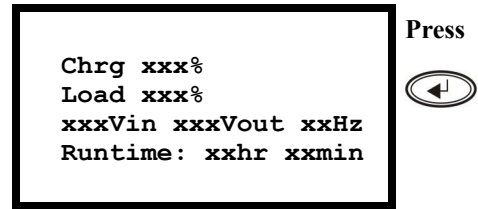

2. Go to **Setup** by using the **UP/DOWN** navigation keys and press **ENTER**.

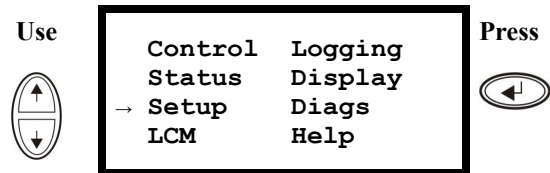

3. Go to **Clock** by using the **UP/DOWN** navigation keys and press **ENTER**.

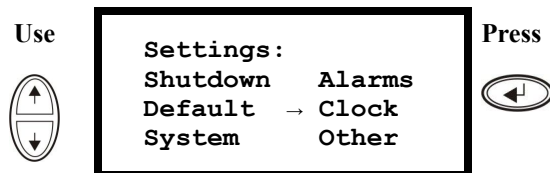

4. Press **ENTER**.

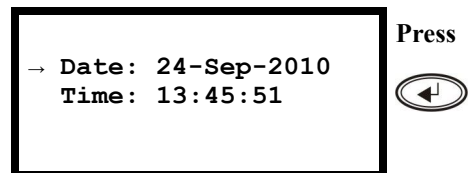

5. The day is now active. Use the **UP/DOWN** navigation keys to set the date and press **ENTER**.



6. The month is now active. Use the **UP/DOWN** navigation keys to set the month, press **ENTER** and do the same to set the year, and press **ENTER**.



- Press the **DOWN** navigation key to activate the **Time** line.

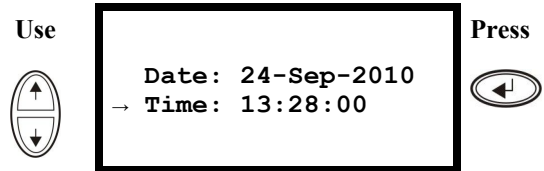

- The procedure to change the **Time** features is the same as described for date, month, and year.

Press



Dust Filter



Note: When a dust filter is installed for the first time or when a UPS is installed with factory pre-installed dust filter, then the dust filter surveillance should be enabled. The parameters are **High**, **Medium**, or **Low**. A **High** parameter selection is for heavy dust environments and will prompt the user to replace the dust filter after 90 days. A **Medium** parameter selection will prompt the user to replace the dust filter after 120 days and a **Low** parameter selection will prompt the user to replace the dust filter after 150 days. A pre-warning will appear five days before the filter must be replaced. If a filter needs replacement, (when the existing filter is filled with dust and an alarm has been initiated) then you must replace the filter and make sure that the **Reset dust filter** setting is set to **Yes**. Firmware upgrade or enabling the dust filter surveillance is not applicable for UPS models which do not have the capability of running in parallel.

- From the Overview Screen, press **ENTER**.

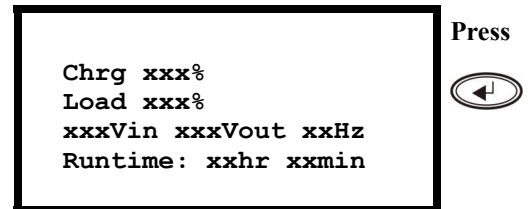

- Go to **Setup** by using the **UP/DOWN** navigation keys and press **ENTER**.

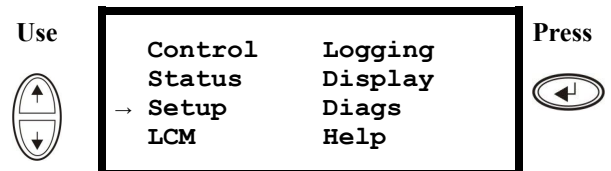

- Go to **System** by using the **UP/DOWN** navigation keys and press **ENTER**.

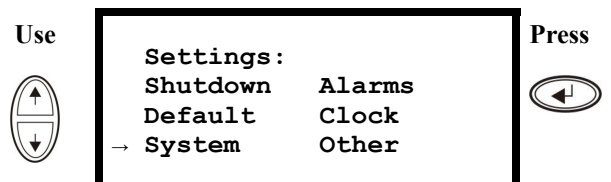

4. Go to **Dust filter** by using the **UP/DOWN** navigation keys and press **ENTER**.

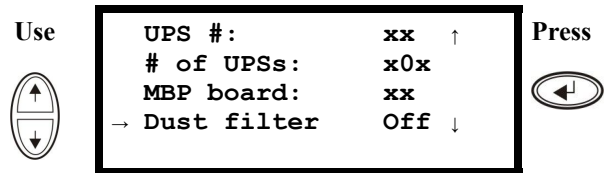

Note: The default setting of the dust filter alarm is “off”. By choosing one of the three parameters (“High”, “Medium”, or “Low”) the dust filter surveillance is automatically turned on.

5. Go to **Dust filter: High, Medium, Low or Off** by using the **UP/DOWN** navigation keys and press **ENTER**.

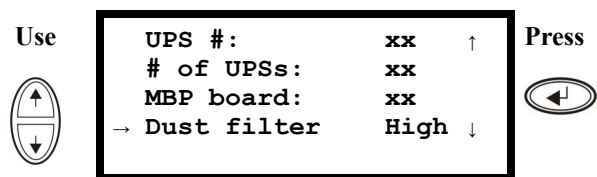

Note: The dust filter surveillance must be reset after every dust filter replacement in order for the UPS system to know when the filter needs to be replaced again.

6. Reset the dust filter surveillance: Carry out steps 1–3 above and then proceed with the below steps.

7. Go to **Reset dust fil** by using the **UP/DOWN** navigation keys and press **ENTER**.

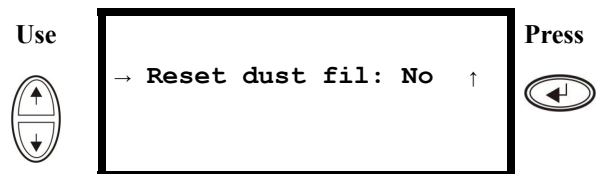

8. Go to **Reset dust fil: Yes** by using the **UP/DOWN** navigation keys, and press **ENTER**. Note! The menu will fall back to **No** after a few seconds. Now the filter timer is reset.

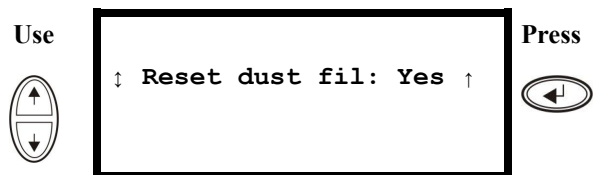

Alarm Thresholds

The procedure for changing the **Alarm** thresholds is the same as described under the **Clock** changes. Be aware of the below notes.



Note: If the load level exceeds the pre-programmed threshold, the UPS will display a warning.



Note: Redundancy: The state of redundancy that will trigger an alarm. Choices are:

- N+0 – The power requirement exceeds the redundancy limit: Redundancy is not available.
- N+1 – The power requirement does not utilize the last unit: Redundancy is available.
- N+2 – The power requirement does not utilize the last two units: Redundancy is available.
- N+3 – The power requirement does not utilize the last three units: Redundancy is available.

Change the Beeper Setup, the Contrast, and the Language

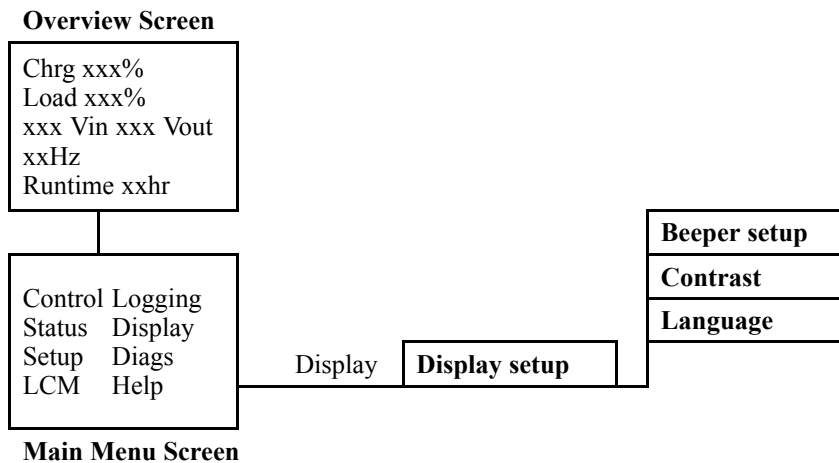

Work your way through the menu screens and make your changes with the **UP/DOWN** and the **ENTER** keys as described for the **Clock** and the **Alarms** in the **Settings** menu.

The Beeper setup

In the **Beeper setup** you can choose between the following options:

- **Never:** If you select this setting, the beeper will be active at internal UPS errors only.
- **PwrFail+30:** If you select this setting, the beeper will be active at internal UPS errors and at utility/mains or bypass errors. The beeper will only sound if the fault has been present for more than 30 seconds.
- **PwrFail:** If you select this setting, the beeper will be active at internal UPS errors and at utility/mains or bypass errors. The beeper will sound immediately when the error is occurring.
- **LOW BATT:** If you select this setting, the beeper will be active at internal UPS errors at utility/mains or bypass errors, at power failures, and at a low battery level (if the UPS runs in battery operation).

Maintenance



WARNING: For safety reasons, only qualified personnel is allowed to perform the replacement procedures described in this chapter.

Parts Replacement

Determine if you Need a Replacement Part

To determine if you need a replacement part, contact APC Customer Support and follow the procedure below so that the APC Customer Support representative can assist you promptly:

1. In the event of a module failure, the display interface may show additional “fault list” screens. Press any key to scroll through these fault lists, record the information, and provide it to the representative.
2. Write down the serial number of the unit so that you will have it easily accessible when you contact APC Customer Support.
3. If possible, call APC Customer Support from a telephone that is within reach of the UPS display interface so that you can gather and report additional information to the representative.
4. Be prepared to provide a detailed description of the problem. A representative will help you solve the problem over the telephone, if possible, or will assign a Return Material Authorization (RMA) number to you. If a module is returned to APC, this RMA number must be clearly printed on the outside of the package.
5. If the unit is within the warranty period, repairs or replacements will be performed free of charge. If it is not within the warranty period, there will be a charge.
6. If the unit is covered by an APC service contract, have the contract available to provide information to the representative.

Return Parts to APC

Call APC Customer Support to obtain an RMA number.

To return a failed module to APC, pack the module in the original shipping materials, and return it by insured, prepaid carrier. The APC Customer Support representative will provide the destination address. If you no longer have the original shipping materials, ask the representative about obtaining a new set. Pack the module properly to avoid damage in transit. **Never use styrofoam beads or other loose packaging materials when shipping a module, as the module may settle in transit and become damaged.** Enclose a letter in the package with your name, RMA number, address, a copy of the sales receipt, description of the problem, a phone number, and a check as payment (if necessary).



Note: Damages sustained in transit are not covered under warranty.

Remove the Front Panel

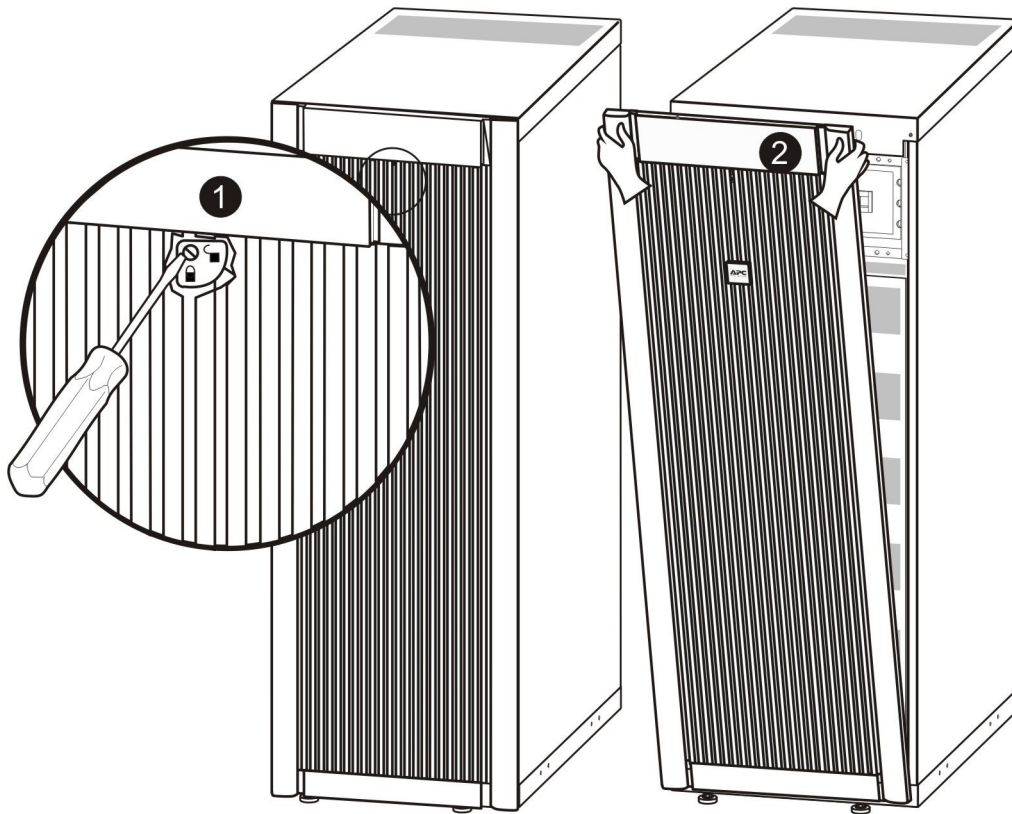

1. Turn the screw to the right to the unlocked position.
2. Pull the top of the front panel away from the UPS.
3. Lift the front panel free of the two slots at the bottom of the enclosure.
4. Lift the battery compartment cover free of the two slots at the bottom of the enclosure (only applicable in Japanese configurations).

Install the Front Panel

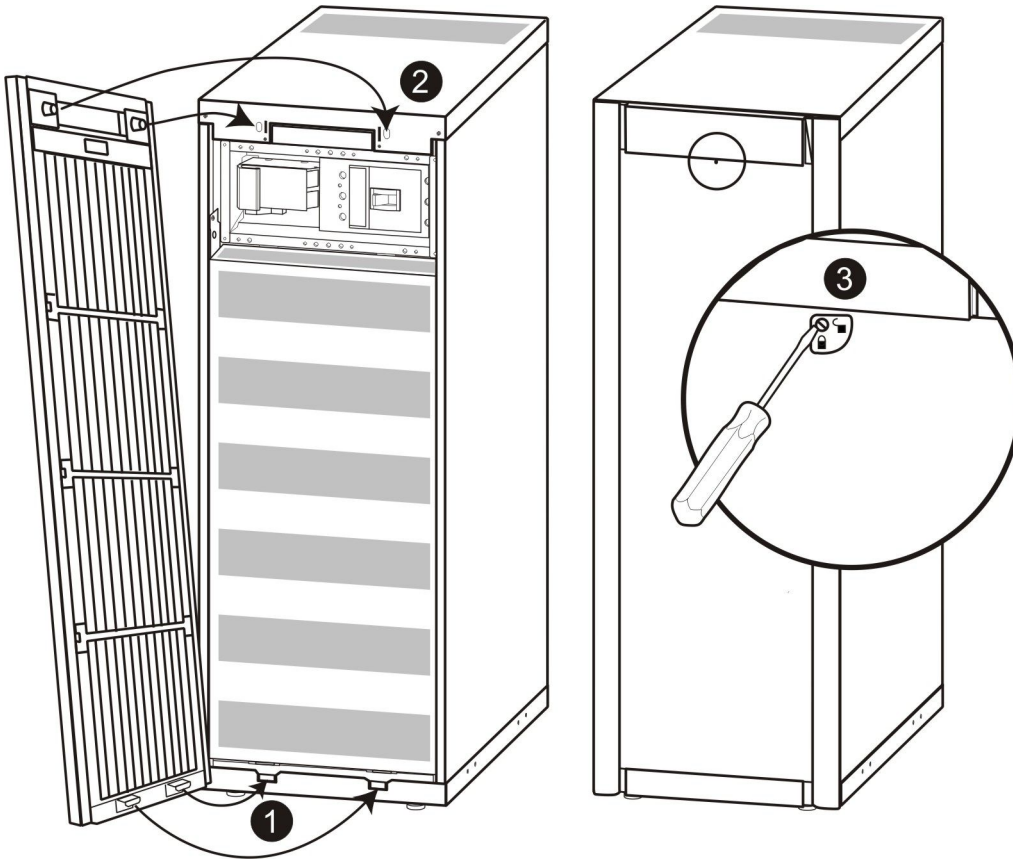

1. Reinstall the front panel by inserting the two tabs at the bottom of the front panel. (For Japanese configurations, you must first reinstall the battery compartment cover into the two slots at the bottom of the enclosure).
2. Push the front panel forward until it engages the locking devices at the top of the enclosure.
3. Use a screwdriver to set the lock mechanism to the locked position.

Store the Batteries and the UPS System



Note: The battery modules must be stored indoors and with their protective packaging still in place.



Note: Stored batteries should be recharged at regular intervals, depending on the storage temperature:



Ambient temperature: -15°C to 40°C/ 5°F to 104°F	Relative Humidity: 0-95% Non-condensing	Storage place free from vibration, conductive dust, direct sunlight, and moisture.

Storage Temperature	Recharge Interval
-15° to 20°C/5°F to 68°F	9 months
20° to 30°C/68°F to 86°F	6 months
30° to 40°C/86°F to 104°F	3 months



Caution: Do not store the batteries for more than 12 months.

Store the Dust Filter

	
Ambient temperature: 4°C to 32°C/ 40°F to 90°F	Relative Humidity: 40%–90% Non-condensing

User- Replaceable Parts (only Qualified Personnel)

Part	APC Part Nos.
Battery Module	SYBT4
Network Management Card with temperature sensor	AP9631
Dust filter kit for low, narrow (352 mm) UPS enclosures (10, 15, and 20 kVA)	SUVTOPT012
Dust filter kit for low, wide (523 mm) UPS enclosures (30 and 40 kVA)	SUVTOPT013



Note: APC recommends that a whole battery module (four batteries) is replaced at the same time to ensure optimal runtime. However, it is only necessary to replace two batteries at the same time. See *“Directions for Replacement”*.

User Interface (Front)

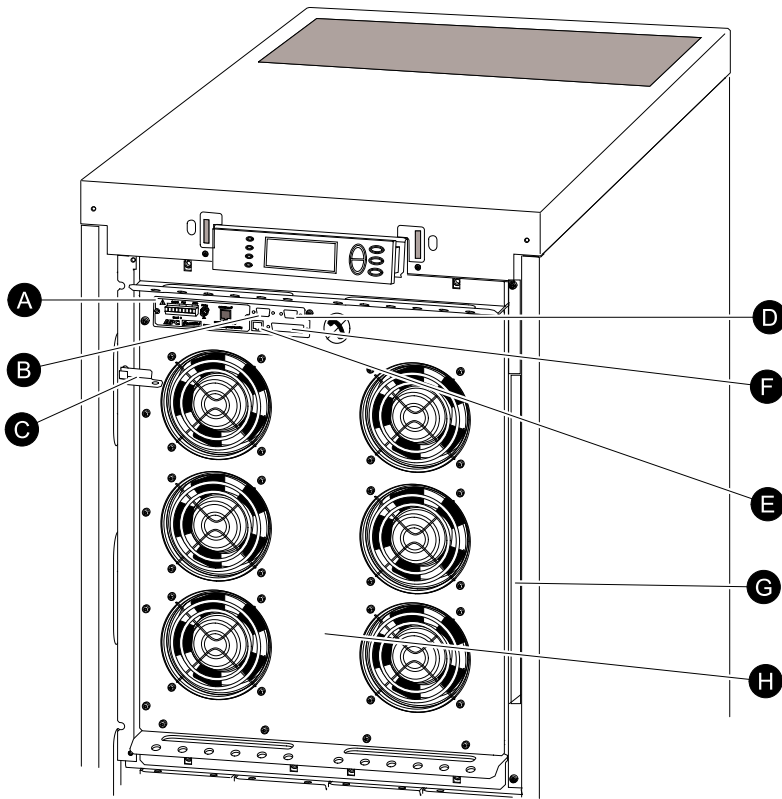

- A. Network Management Card with temperature sensor: used for remote system control and monitoring, e-mail notifications etc. For configuration and use, refer to the separate user manual: Network Management Card with Environmental Monitor – shipped with the UPS.
- B. Computer-interface port for the connection of computers with APC Powerchute® software.
- C. Internal mechanical bypass lever: used to bypass the upstream utility/mains power around the UPS to support the load directly = internal bypass operation. Not applicable in parallel systems.
- D. Service port (for APC maintenance personnel only).
- E. Display port for the connection of display communication cable.
- F. Parallel operation port.
- G. Documentation storage.
- H. Power module.

Replace a Network Management Card

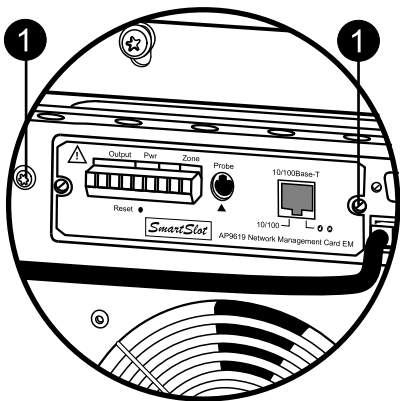

1. Loosen the two Torx screws (one on each side of the card).
2. Carefully pull out the card.

3. Install the new card.
4. Reattach the two Torx screws.

Install/ replace a Dust Filter



Note: Dust filters are only available for the two low Smart-UPS VT versions without batteries.



Note: Only graphics of the low and wide (523 mm) Smart-UPS VT enclosure are shown, but the procedures apply to both enclosure sizes.



WARNING: Only trained personnel familiar with the construction of the UPS may install and remove a dust filter.



Caution: The dust filter must be installed in the front panel by keeping the front panel on a levelled floor.



Note: Do not reuse the filter by cleaning the dust in the filter.



Note: For non-parallel versions (for which dust filter surveillance is inapplicable) the dust filter must be checked periodically and if the filter shows visible high signs of dust accumulation, it must be replaced.

Installation – Insert Filter Clips

1. Remove the front panel. See **“Remove the Front Panel”**.
2. Open the air filter kit and insert 12 clips in the locations shown in the drawing.

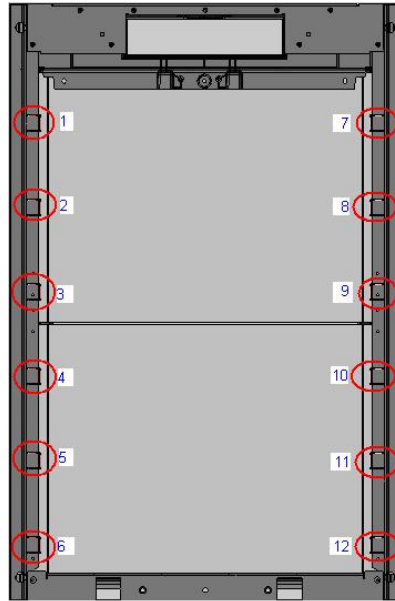

Installation – Insert Dust Filter

1. Remove the front panel. See **“Remove the Front Panel”**.
2. Remove the dust on the front panel by using a brush or air blower. While cleaning the front panel, keep the front panel away from the UPS.
3. Insert filter clips if not already done at this point. See **“Installation – Insert Filter Clips”** step 2.
4. Press and slide the filter under each clip starting from the top and working your way down.

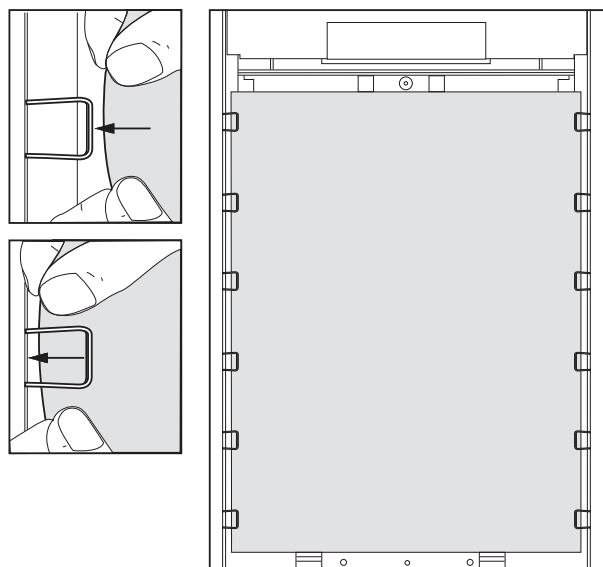

5. Install the front panel. See **“Install the Front Panel”**.
6. Enable the dust filter surveillance. See **“Dust Filter”**.

Replacement – Replace Dust Filter

1. Remove the front panel. See “*Remove the Front Panel*”.
2. Remove the filter by sliding it out under the clips. Keep the clips attached to the enclosure.

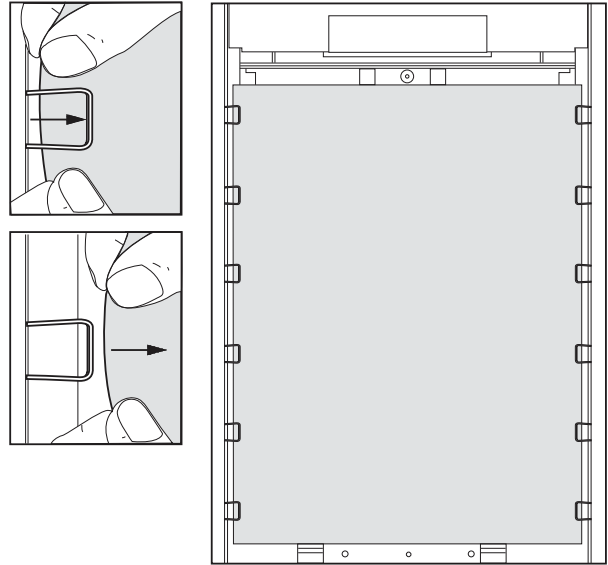

3. Remove the dust on the front panel by using a brush or air blower. While cleaning the front panel, keep the front panel away from the UPS.
4. Take the new dust filter from the kit.
5. Insert the new dust filter. See “*Installation – Insert Dust Filter*”, from step 2.
6. Install the front panel. See “*Install the Front Panel*”.
7. Reset the dust filter surveillance. See “*Dust Filter*”, from step 6.
8. Dispose the old filter appropriately.

Replace a Battery Module

General safety prior to battery module replacement



Note: When replacing battery modules, replace with same part number.



Caution: Batteries must be replaced by qualified personnel only.



Caution:

Servicing of batteries should be performed or supervised by personnel knowledgeable of batteries and the required precautions. Keep unauthorized personnel away from batteries.

Do not dispose of battery or batteries in a fire. The battery may explode.

Do not open or mutilate the battery or batteries. Released electrolyte is harmful to the skin and eyes. It may be toxic.

A battery can present a risk of electrical shock and high short circuit current. The following precautions should be observed when working on batteries:

- Remove watches, rings, or other metal objects.
- Use tools with insulated handles.
- Wear rubber gloves and boots.
- Do not lay tools or metal parts on top of batteries.
- Disconnect charging source prior to connecting or disconnecting battery terminals.



Caution: Use two people to lift components weighing between 18–32 kg/40–70 lb.

Battery Module

One battery module consists of four battery units (shipping in the enclosures).

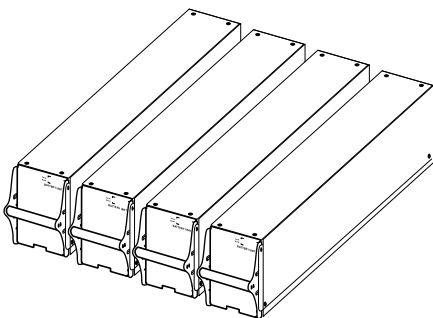

4 x 24 kg/4 x 53 lbs

Remove and Install Battery Locks

If your system is equipped with battery locks, follow the below procedure to remove the battery locks.

1. Remove the M6 screw attaching the battery lock to the shelf.

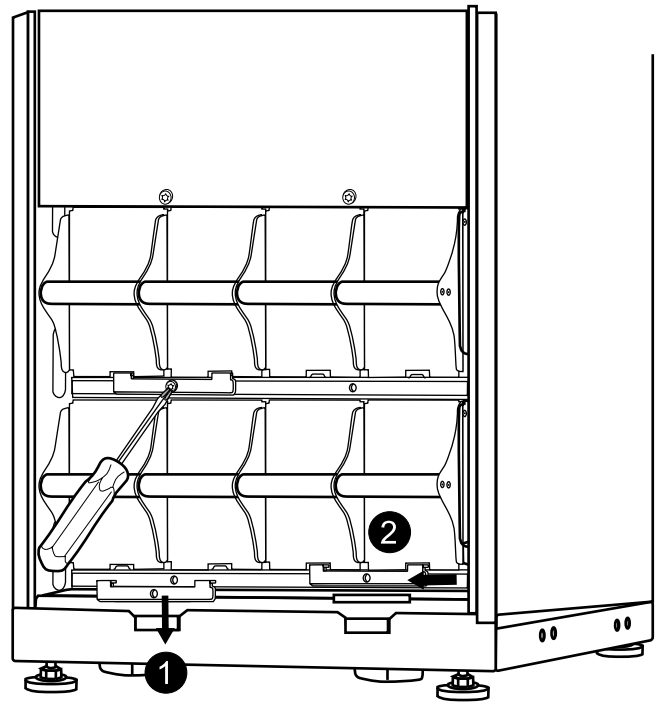

2. Push the battery lock to the left, push it upwards and remove.
3. Use the reverse procedure for the installation of battery locks.

Battery Replacement



Caution: Batteries must be replaced by qualified personnel only *“Replace a Battery Module”*.

Directions for Replacement

APC recommends that a whole battery module (four batteries) is replaced at the same time to ensure optimal runtime (see Example 1). However, it is only necessary to replace two batteries at the same time according to Example 2 and 3 in the below tables.

523 mm/(20 in) Enclosure	Column A	Column B	Column C	Column D
Example 1	New	New	New	New
Example 2	New	New	Old	Old
Example 3	Old	Old	New	New

352 mm/(14 in) Enclosure	Column A	Column B
Example 1	New	New
	New	New
Example 2	New	New
	Old	Old
Example 3	Old	Old
	New	New

Follow the below procedures if you need to change or add a battery module, e.g. if you receive a display message reporting a bad battery, or if you need to add batteries for increased runtime.

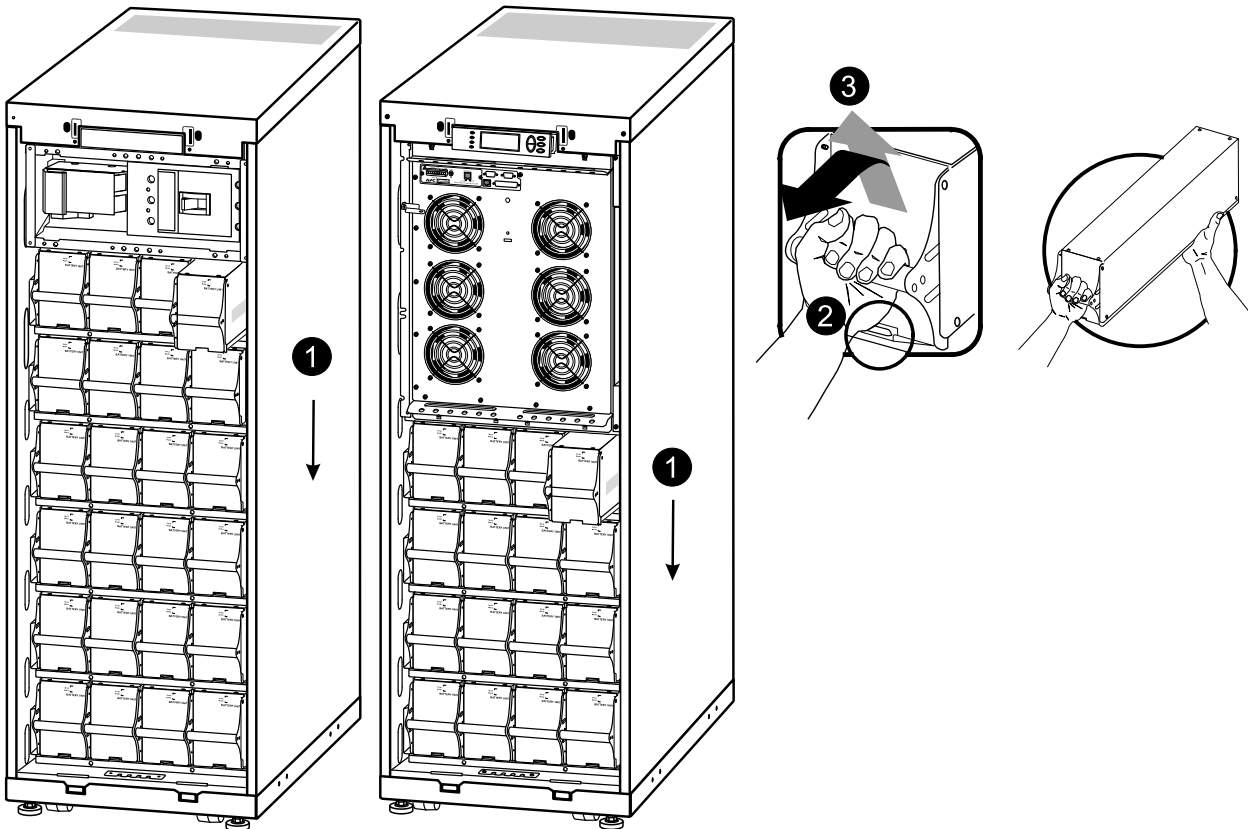

1. When removing battery modules, start from the highest level and work down.
2. Holding the battery handle, gently push the battery upwards and pull it halfway out of the enclosure. A lock mechanism prevents it from being pulled all the way out.
3. To release the battery from the lock mechanism, gently push the battery upwards again and pull it out, while another person supports the battery.

Installation

If additional batteries are needed for extra runtime, or if you install battery replacement modules, be aware of the following:



Caution: Do not install battery modules in the UPS until you are ready to power up the system. Disregarding this caution can result in a deep discharge of the batteries and cause permanent damage. The time between battery installation and powering up the UPS should not exceed 72 hours/ three days.

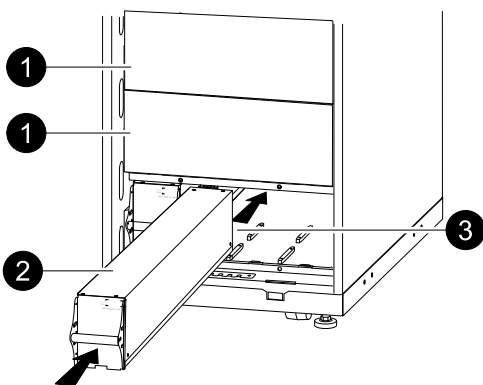

1. Remove possible blind plate in front of possible empty battery shelves (save the screws for later use).

2. Install the battery module in the lowest available bay (four across in 523 mm/(20 in) UPS versions, two across in 352 mm/(14 in) UPS versions).
3. Position the battery unit to slide in between the grooves and push it completely into the UPS to ensure connection.



Note: If a problem is reported, ensure that the modules in question are correctly installed. If the problem persists, see the section “Troubleshooting” on page 35.



Note: Allow for a 24-hour recharging period of the batteries after system start-up.

Troubleshooting

Status and Alarm Messages

This section lists the status and alarm messages that the UPS might display. The messages are listed in alphabetical order, and a suggested corrective action is listed with each alarm message to help you troubleshoot problems.

Display Messages

Display Message	Meaning	Corrective Action
Automatic Self Test Started.	The UPS has started pre-programmed battery test.	No corrective action is necessary.
ABus Communication Fault.	Communication fault detected on the ABus.	Check ABus wiring. If this does not help contact APC.
ABus Termination Fault.	ABus termination is missing.	Check if termination is present. If this does not help contact APC.
Batt Temperature Exceeded Upper Limit.	The temperature of one or more battery units has exceeded the system specifications.	Contact APC Customer Support (see the back cover).
Battery over-voltage warning.	The battery voltage is too high and the charger has been deactivated.	Contact APC Customer Support (see the back cover).
Bypass Not Available Input Freq/Volt Out Of Range.	The frequency or voltage is out of acceptable range for bypass. This message occurs when the UPS is online, and indicates that the bypass mode may not be available if required.	Correct the input voltage to provide an acceptable voltage or frequency.
Battery Discharged.	The UPS is in battery operation and the battery charge is low. Note: Runtime is limited in duration.	No corrective action is necessary. Shut down the system and the load equipment or restore incoming voltage.
Emergency PSU Fault.	The redundant Emergency Power Supply Unit (PSU) is not working. The UPS will continue to work normally, but the PSU should be replaced.	Contact APC Customer Support (see the back cover).
EPO Activated.	The Emergency Power Off switch has been activated.	Deactivate the Emergency Power Off switch.
Fan fault.	A fan has failed.	Contact APC Customer Support (see the back cover).
Int. Mech. Bypass Switch Closed.	The internal mechanical switchgear is closed.	No corrective action necessary. The UPS is in internal mechanical bypass operation.
Int. Mech. Bypass Switch Open.	The internal mechanical switchgear is OFF.	No corrective action is necessary.
Low-Battery.	The UPS is in battery operation and the battery charge is low. Note: Runtime is limited in duration.	Shut down the system and the load equipment or restore incoming voltage.
Load Is No Longer Above Alarm Threshold.	The load previously exceeded the alarm threshold and the situation has been corrected either because the load decreased or the threshold was increased.	No corrective action is necessary.

Display Message	Meaning	Corrective Action
Load Power Is Above Alarm Threshold.	The load has exceeded the user-specified load alarm threshold.	Option 1: Use the display interface to raise the alarm threshold. Option 2: Reduce the load.
Mains Not Available. Input Freq/Volt Out of Range.	The frequency or voltage is out of acceptable range for normal operation.	Correct the input voltage to provide acceptable voltage or frequency.
Minimum Runtime Restored.	The system runtime dropped below the configured minimum and has been restored. Additional Battery Modules were installed, the existing Battery Modules were recharged, the load was reduced, or the threshold was decreased.	No corrective action is necessary.
No Batteries Are Connected.	No battery power is available.	Check that the batteries are inserted properly.
No Master is Present in the Parallel System.	No parallel master is present. The parallel system will not be able to function properly.	Contact APC Customer Support (see the back cover).
Number of Battery Modules Decreased.	One or more battery modules were removed.	No corrective action is necessary.
Number of Battery Modules Increased.	One or more battery modules were added.	No corrective action is necessary.
Overload on a Parallel Unit.	One or more systems has overload. Note that the entire parallel system will not be able to return from bypass.	No corrective action is necessary.
Order Startup Check.	The UPS system has been on for five days.	Contact APC Customer Support to verify the installation (see the back cover).
Order Tech Check.	The UPS system has been on for four years. A technical check is recommended.	Contact APC Customer Support (see the back cover).
PBus Communication Fault on Cable 1.	Communication fault detected on PBus 1.	Check PBus 1 wiring. If this does not help contact APC.
PBus Communication Fault on Cable 2.	Communication fault detected on PBus 2.	Check PBus 2 wiring. If this does not help contact APC.
PBus Termination Fault on Cable 1.	PBus 1 termination is missing.	Check if termination is present. If this does not help contact APC.
PBus Termination Fault on Cable 2.	PBus 2 termination is missing.	Check if termination is present. If this does not help contact APC.
Parallel Configuration Fault.	The parallel system has not been configured correct.	Contact APC Customer Support (see the back cover).
Parallel Redundancy Restored.	The parallel redundancy has been restored.	No corrective action is necessary.
Parallel Redundancy is below Alarm Threshold	The load has exceeded the user specified load alarm threshold.	Option 1: Use the display interface to raise the alarm threshold Option 2: Reduce the load. Parallel redundancy is now restored.
Replace Batt(s).	One or more Battery Modules need replacement (only applicable with internal batteries).	See the section “Parts Replacement” for procedures.

Display Message	Meaning	Corrective Action
Runtime Is Below Alarm Threshold.	The predicted runtime is lower than the user-specified minimum runtime alarm threshold. Either the battery capacity has decreased, or the load has increased.	Option 1: Allow the battery modules to recharge. Option 2: If possible, increase the number of battery modules. Option 3: Reduce the load. Option 4: Decrease the alarm threshold. Contact APC Customer Support (see the back cover)
Shutdown Due To Low Battery.	The UPS was in Battery Operation and shut down the load when no more battery power was available.	No corrective action is necessary. Note: If the problem reoccurs, consider increasing the battery capacity.
Site Wiring Fault.	Wrong phase rotation on the input side. The UPS will continue to supply conditioned power from batt.	An electrician should check that the UPS has been wired properly.
Static Bypass Switch Fault.	The Static Bypass Switch has failed.	Contact APC Customer Support (see the back cover).
System Failure Detected by Surveillance.	The system has detected an internal error.	Check for other alarms and contact APC customer support if the problem persists.
System Start Up Configuration Failed.	System configuration error. Unable to determine system voltage and/or enclosure size.	Check for other alarms and contact APC customer support if the problem persists.
System Not Synchronized to Bypass.	The system cannot synchronize to bypass. The mode may not be available.	Option 1: Decrease the input frequency sensitivity. Contact APC Customer Support (see the back cover) Option 2: Correct the bypass input voltage to provide acceptable voltage or frequency.
The dust filter must be changed immediately.	-	Replace the dust filter.
The dust filter must be changed soon.	-	Be prepared to change the dust filter soon.
UPS In Bypass Due To Fault.	The UPS has transferred to Bypass Mode because a fault has occurred.	Contact APC Customer Support (see the back cover).
UPS In Bypass Due To Overload.	The load exceeded the power capacity. The UPS has switched to Bypass Mode.	Decrease the load.
UPS Is Overloaded.	The load exceeded the system power capacity.	Option 1: Decrease the load. Option 2: Check the load distribution on the 3 phases via the display. If the load is unevenly distributed, adjust the load distribution.
Warranty Expiring.	The warranty expires in three months.	Contact APC Customer Support (see the back cover).
Weak Batt(s) Detected. Reduced Runtime.	One or more weak batteries detected.	Replace the weak batteries.
XR Battery Fuse Blown.	XR Battery Fuse blown. Runtime is lower than expected.	Replace the blown fuse in XR Enclosure (only applicable if your installation includes an XR Enclosure).

Worldwide Customer Support

Customer support for this or any other product is available at no charge:

- Contact the Customer Support Center by telephone or e-mail. For local, country-specific centers: go to www.apc.com/support/contact for contact information.

© APC by Schneider Electric. APC and the APC logo are owned by Schneider Electric Industries S.A.S., American Power Conversion Corporation, or their affiliated companies. All other trademarks are property of their respective owners.